



Technical Data

SierraSeries® Solid Color Reinforced Composite Partition and Screens

1090 SERIES

SPECIFICATION

Height: 58" (1473mm) Doors and Panels with 12" (305mm) Floor Clearance

MATERIAL

Stiles* — 3/4" (19mm) thick, SCRC with GraffitiOff™ surface thermoset and integrally fused into one homogenous piece. Surface, edge, core are to be the same color. *Stiles for 1096 Series floor-to-ceiling anchored units have a leveling device at each end.

Standard Size Stiles:

- For compartments — 3", 4", 5", 6", 7", 8", 10", 12", 16", 18", 20", or 24" (76, 102, 127, 152, 179, 203, 254, 305, 406, 457, 508, 610mm) wide.
- For screens — 6" (152mm) wide.
- Floor-anchored — 69" (1753mm) high.
- Overhead-braced — 83" (2108mm) high.
- Floor-to-ceiling anchored — Up to 120" (3048mm) ceiling height.
- Ceiling-hung — 83" (2108mm) high for 96" (2438mm) ceilings or as required up to 120" (3048mm) ceilings.

Panels — 1/2" (13mm) thick, SCRC with GraffitiOff™ surface thermoset and integrally fused into one homogeneous piece. Surface, edge, core are to be the same color.

Standard Size Panels:

- For compartments — Up to 84" (2134mm) wide; 58" (1473mm) high.

Urinal Screens — 1/2" (13mm) thick, SCRC with GraffitiOff™ surface thermoset and integrally fused into one homogeneous piece. Surface, edge, core are to be the same color.

Standard Size Urinal Screens:

- For wall-hung screens — Up to 24" (610mm) wide; 42" to 54" (1067 to 1372mm) high.
- For ceiling-hung, floor anchored and post-to-ceiling screens — Up to 60" (1524mm) wide; 58" (1473mm) high.

Doors — 3/4" (19mm) thick, SCRC with GraffitiOff surface thermoset and integrally fused into one homogeneous piece. Surface, edge, core are to be the same color.

Standard Size Doors:

- Inswing and outswing doors are standard 22" to 37" (559 to 940mm) wide; 58" (1473mm) high.

Edges SCRC is a natural material comprised of wood chips, dyes and resins with a melamine surface. Edges lack a melamine surface and may discolor in environments with significant UV lighting. Discoloration of edges, should it occur, is not covered under warranty.

Posts (for 1093 Series screens only) — 1 1/4" (32mm) square tubing; 18-8, Type-304, 18-gauge (1.2mm) stainless steel with satin finish. Floor and ceiling connections are constructed of 18-8, Type-304, heavy-gauge stainless steel. Furnished in 120" (3048mm) lengths; to be cut in field to job specifications.

Standard Size Post:

- For 1093 Series post-to-ceiling screens only. 1 1/4" (32mm) square. 120" (3048mm); cut to required height in field.

Headrail (for 1092 Series compartments only) — Extruded anodized aluminum. Enclosed construction with sloping top. Face has raised grip-resistant edge.

Designer's Notes:

- Headrails with integral curtain tracks and hooks are available for compartments without doors. Optional vinyl curtains are available.

Wall Posts — 1" by 1 1/2" (25 by 38mm) wide tubing; 18-8, Type-304, 16-gauge (1.6mm) stainless steel with satin-finish. 58" (1473mm) high, pre-drilled for door hardware.

TOP VIEW OF 1092 (BARREL HINGE AND STANDARD BRACKET) INSTALLATION.

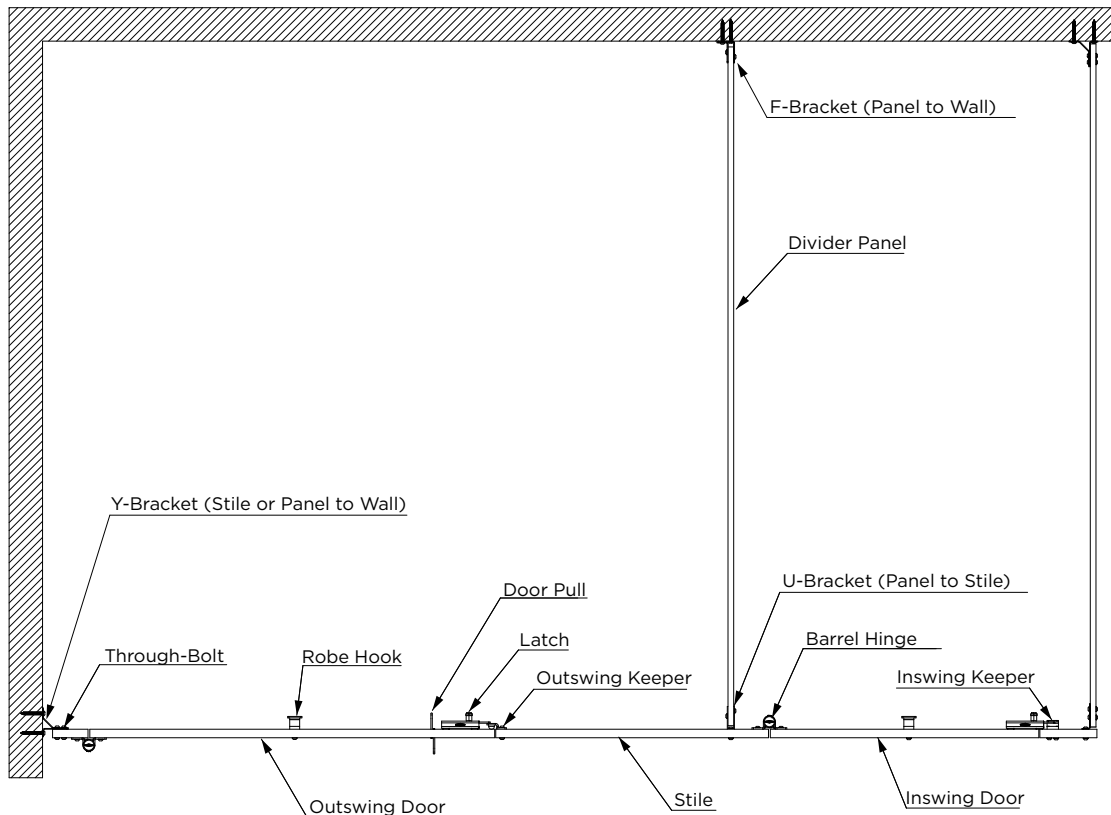

ANCHORING DEVICE:

Leveling Device — 3/16" (5mm) thick, corrosion-resistant, chromate-treated, double zinc-plated steel angle leveling bar bolted to stile; furnished with 3/8" (10mm) diameter threaded rods, hex nuts, lock washers, flat washers, spacer sleeves, expansion anchors, and shoe retainers.

Shoe — 18-8, Type-304, 22-gauge (0.8mm) stainless steel with satin finish; 4" (102mm) high. *Stiles for 1086 Series floor-to-ceiling anchored have a leveling device at each end.

#1002701 FLOOR ANCHOR

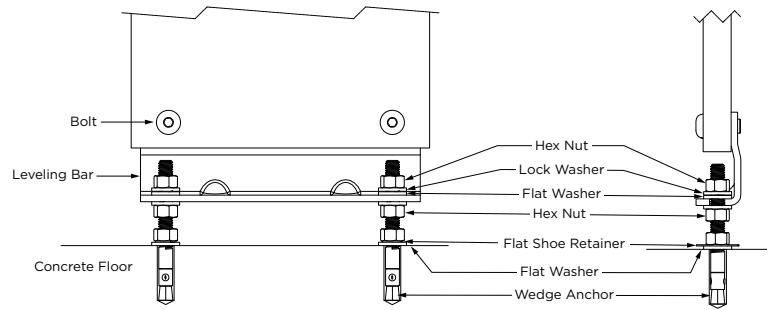

COMMERCIAL HARDWARE (STANDARD)

Hinges, door latch, door keepers, clothes hooks, mounting brackets and door handles are constructed of 18-8, Type-304, heavy-gauge stainless steel with satin finish.

Threaded inserts are factory installed for securing hinges and door latch. Theft-resistant, stainless steel pin-in-head, torx screws are furnished for door hardware and all mounting brackets. Mounting screws for stile to panel bracket, latch keeper, and coat hook connections are through-bolted.

Balanced hinge is adjustable to hold door of unoccupied toilet compartment partially open or fully closed.

Toilet compartment door is locked from inside by sliding door latch into keeper. A locked compartment may be opened from outside by lifting door to disengage latch from keeper. Track of door latch prevents inswing door from swinging out beyond stile; on outswing door, the door keeper prevents it from swinging in beyond stile. Door handles and latch have operable parts that are operable with one hand and do not require tight grasping, pinching, or twisting of the wrist; and comply with ADA Sections 404.2.7 and 309.4. The force required to activate the operable parts shall be 5 pounds (22.2N) maximum. Black rubber bumper on the latch serves as door bumper for inswing door.

#1040-42 LATCH ASSEMBLY

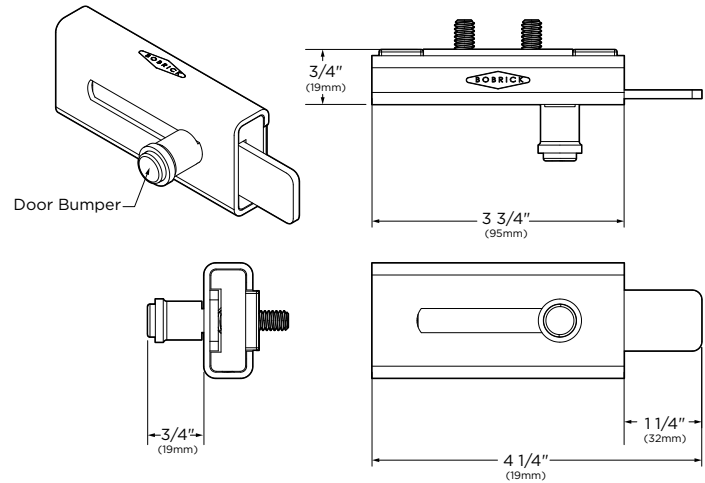

1040-35 KEEPER, INSWING

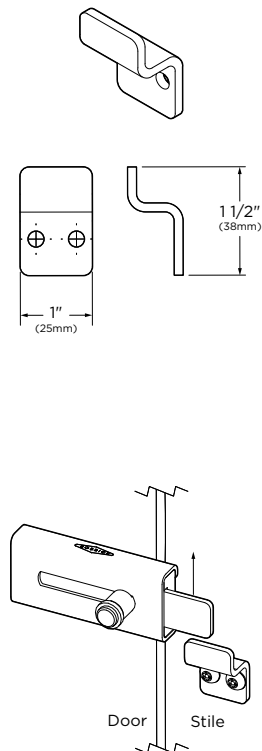

1040-36 KEEPER, OUTSWING

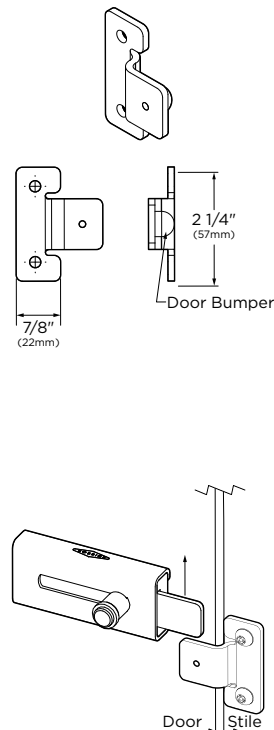

1040-39 PERPENDICULAR

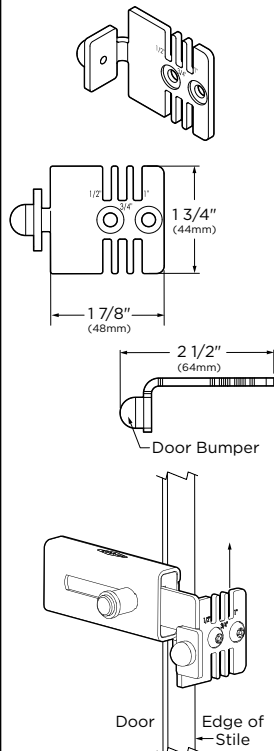

#1040-56 WALL MOUNTED KEEPER INSWING

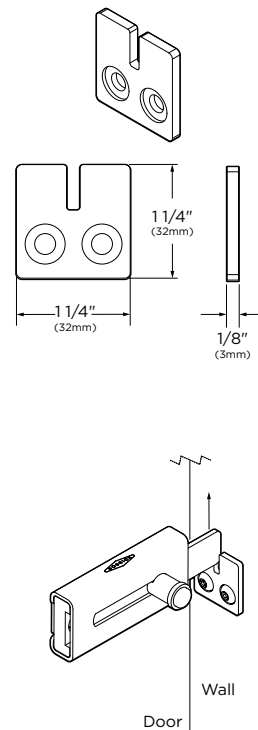

#1000869 COAT HOOK

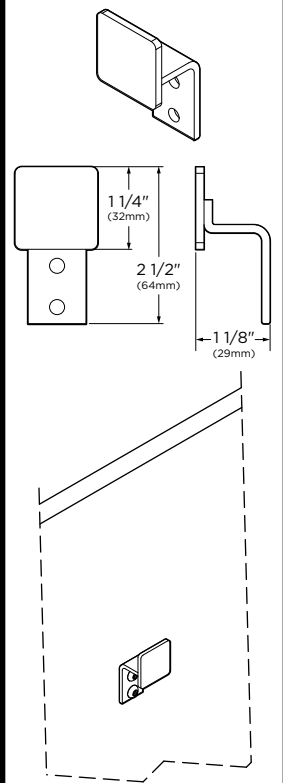

**#1002330
BARREL HINGE SET, L**

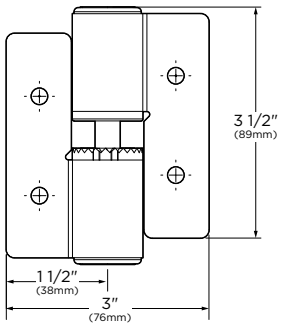

**#1002331
BARREL HINGE SET, J**

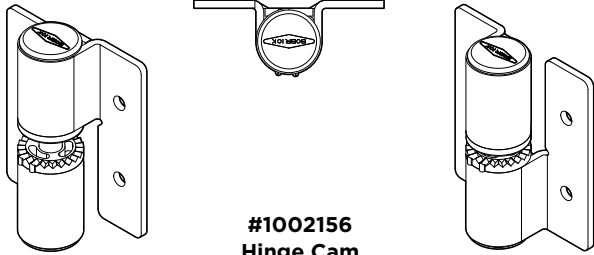
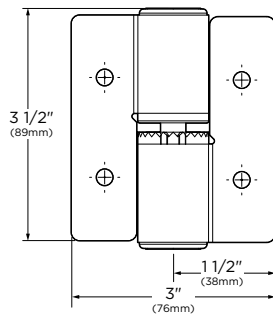

**#1002156
Hinge Cam**

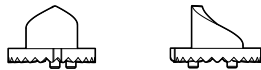

CAM SETTINGS

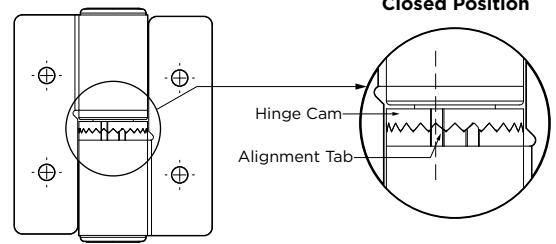

Door Beyond Closed Position

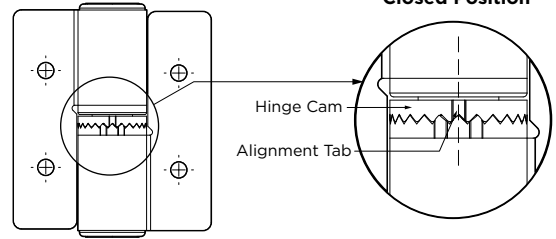

Door Normal Closed Position

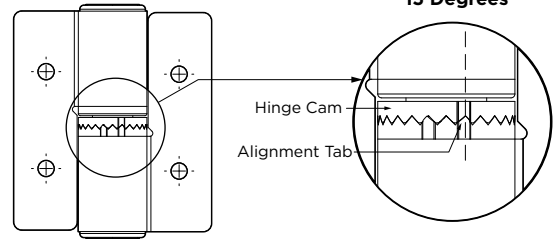

Door Remain Open 15 Degrees

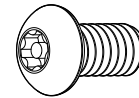

**#1002491
1/4-20 x 1/2" (M6-1 x13mm)
Pin-in-Head Torx Screw**

Hinges are constructed of 18-8, Type-304, heavy-gauge stainless steel with satin finish. Threaded inserts are factory installed for securing hinges. Theft-resistant, stainless steel pin-in-head, torx screws are furnished for door hardware. Balanced hinge is adjustable to hold door of unoccupied toilet compartment partially open or fully closed.

BRACKETS (STANDARD):

**#1000282
Alcove Bracket
(1/2" Panel to 3/4" Stile)**

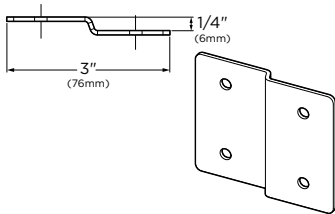

**#1000351
L-Bracket
(Panel to Corner Stile)**

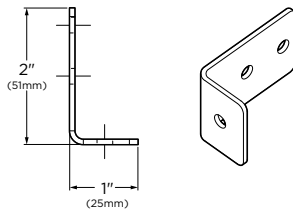

**#1000972
U-Bracket
(Panel to Perp. Stile)**

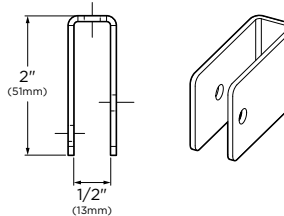

**#1002664
#10-24 x 3/8" Button Head
Torx Screw (to attach to sex-bolt
fastener through 1/2" panel)**



**#1000974
Y-Bracket
(Stile to Wall)**

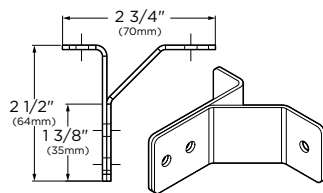

**#1000975
F-Bracket
(Panel to Wall)**

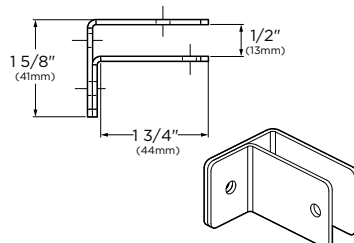

**#1002499
#12 x 7/16" Pin-in-Head Torx Screw
(M5.5 x 11mm)**



**#1002665
#10-24 x 5/8" Button Head
Torx Screw (to attach to sex-bolt
fastener through 3/4" stiles)**

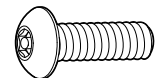

**#1002495
#12 x 2" Pin-in-Head Torx Screw
(M5.5 x 50mm) Wall Screw**

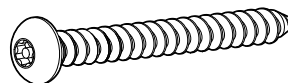

**#1002666
#10-24 Pin-in-Head Sex Bolt,
1/4" Diameter, 1/2" Barrel
(fastener for all through-
bolted locations)**

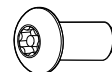

1091 SERIES FLOOR ANCHORED

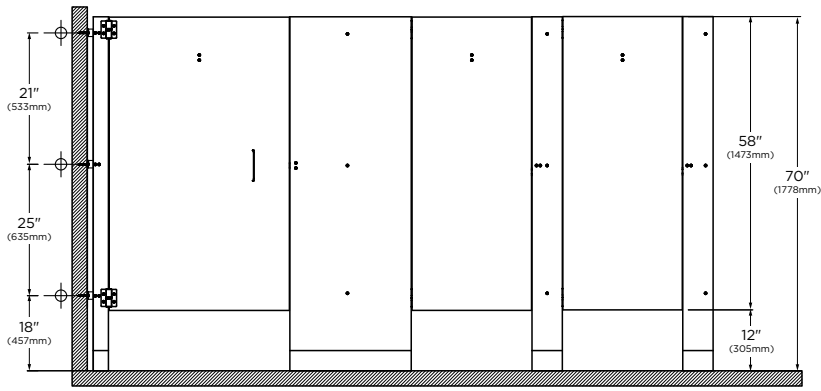

Front View

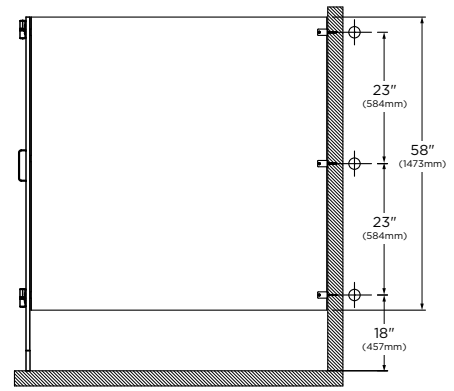

Side View

STANDARD:

- #1091 - Barrel Hinge and Standard Bracket

MODEL OPTIONS:

- #1091.67 - Continuous Hinge and Continuous Bracket
- #1091.67D - Continuous Hinge and Standard Bracket
- #1091.67P - Barrel Hinge and Continuous Bracket

GAPLESS MODEL OPTIONS:

- #1091G - Gapless, Barrel Hinge and Standard Bracket
- #1091G.67 - Gapless, Continuous Hinge and Continuous Bracket
- #1091G.67D - Gapless, Continuous Hinge and Standard Bracket
- #1091G.67P - Gapless, Barrel Hinge and Continuous Bracket

1092 SERIES OVERHEAD-BRACED

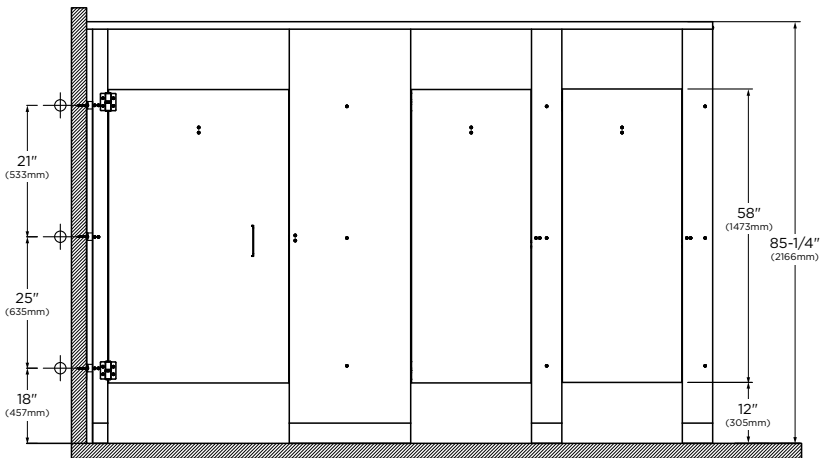

Front View

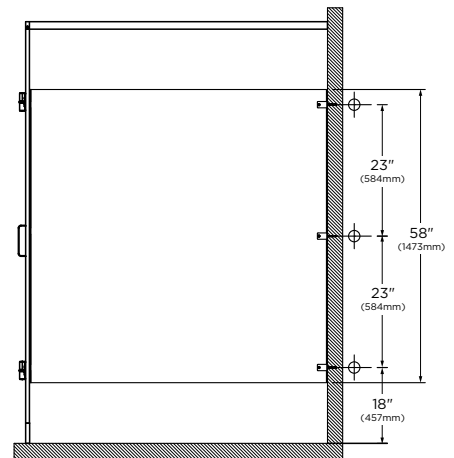

Side View

STANDARD:

- #1092 - Barrel Hinge and Standard Bracket

MODEL OPTIONS:

- #1092.67 - Continuous Hinge and Continuous Bracket
- #1092.67D - Continuous Hinge and Standard Bracket
- #1092.67DDS - Continuous Hinge, Standard Bracket and Door Stop
- #1092.67DS - Continuous Hinge, Continuous Bracket and Door Stop
- #1092.67P - Barrel Hinge and Continuous Bracket

GAPLESS MODEL OPTIONS:

- #1092G - Gapless, Barrel Hinge and Standard Bracket
- #1092G.67 - Gapless, Continuous Hinge and Continuous Bracket
- #1092G.67D - Gapless, Continuous Hinge and Standard Bracket
- #1092G.67DDS - Gapless, Continuous Hinge, Standard Bracket and Door Stop
- #1092G.67DS - Gapless, Continuous Hinge, Continuous Bracket and Door Stop
- #1092G.67P - Gapless, Barrel Hinge and Continuous Bracket

Headrail Installation Detail

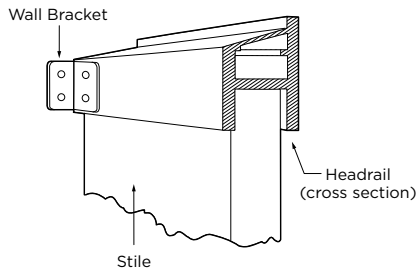

Curtain Track Installation Detail

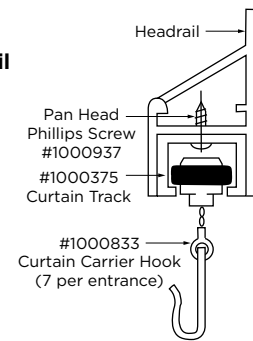

1096 SERIES FLOOR-TO-CEILING



Front View

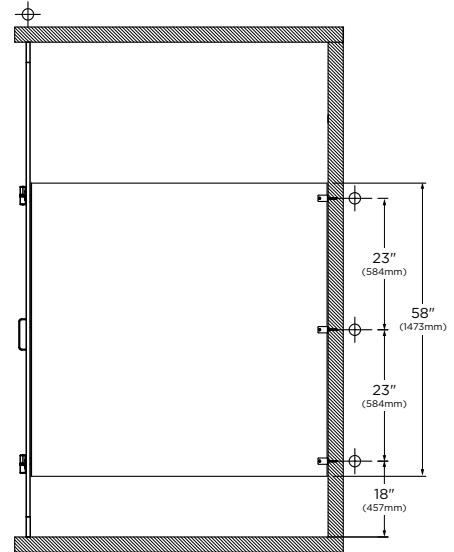

Side View

STANDARD:

- #1096 - Barrel Hinge and Standard Bracket

MODEL OPTIONS:

- #1096.67 - Continuous Hinge and Continuous Bracket
- #1096.67D - Continuous Hinge and Standard Bracket
- #1096.67DDS - Continuous Hinge, Standard Bracket and Door Stop
- #1096.67DS - Continuous Hinge, Continuous Bracket and Door Stop
- #1096.67P - Barrel Hinge and Continuous Bracket

GAPLESS MODEL OPTIONS:

- #1096G - Gapless, Barrel Hinge and Standard Bracket
- #1096G.67 - Gapless, Continuous Hinge and Continuous Bracket
- #1096G.67D - Gapless, Continuous Hinge and Standard Bracket
- #1096G.67DDS - Gapless, Continuous Hinge, Standard Bracket and Door Stop
- #1096G.67DS - Gapless, Continuous Hinge, Continuous Bracket and Door Stop
- #1096G.67P - Gapless, Barrel Hinge and Continuous Bracket

1098 SERIES CEILING HUNG

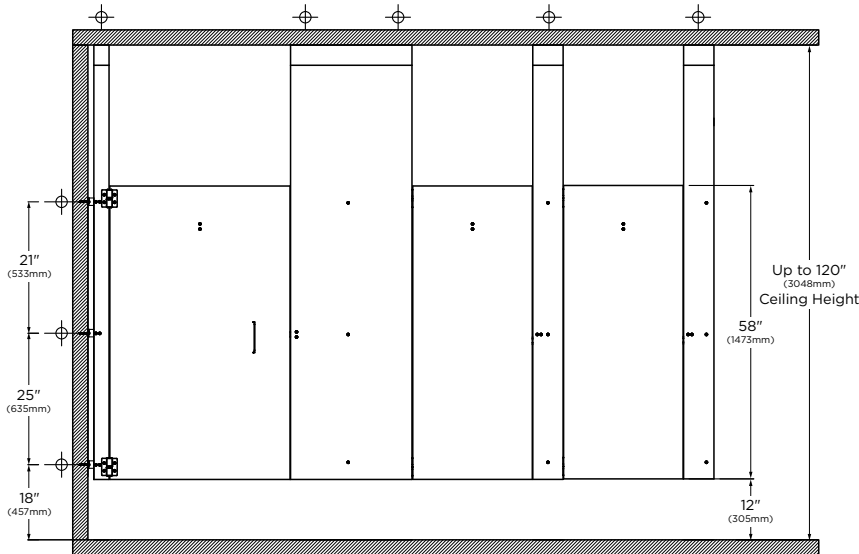

Front View

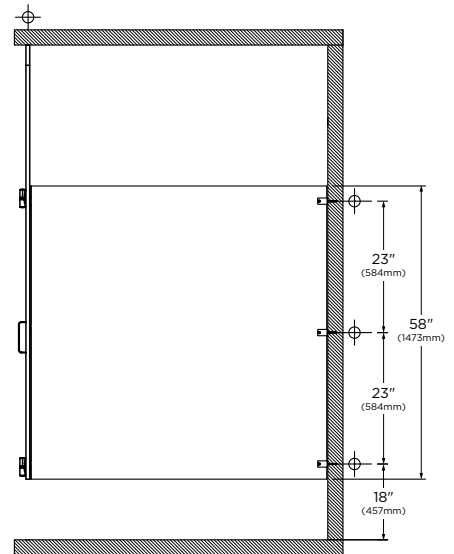

Side View

STANDARD:

- #1098 - Barrel Hinge and Standard Bracket

MODEL OPTIONS:

- #1098.67 - Continuous Hinge and Continuous Bracket
- #1098.67D - Continuous Hinge and Standard Bracket
- #1098.67DDS - Continuous Hinge, Standard Bracket and Door Stop
- #1098.67DS - Continuous Hinge, Continuous Bracket and Door Stop
- #1098.67P - Barrel Hinge and Continuous Bracket

GAPLESS MODEL OPTIONS:

- #1098G - Gapless, Barrel Hinge and Standard Bracket
- #1098G.67 - Gapless, Continuous Hinge and Continuous Bracket
- #1098G.67D - Gapless, Continuous Hinge and Standard Bracket
- #1098G.67DDS - Gapless, Continuous Hinge, Standard Bracket and Door Stop
- #1098G.67DS - Gapless, Continuous Hinge, Continuous Bracket and Door Stop
- #1098G.67P - Gapless, Barrel Hinge and Continuous Bracket

Ceiling Leveling Device

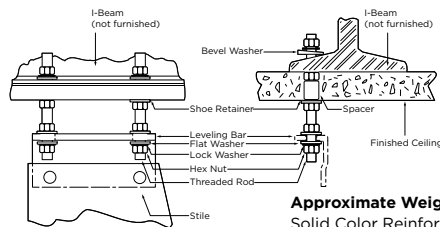

Approximate Weight:

Solid Color Reinforced Composite Toilet Compartment - 275 lbs.

Provisions must be in the construction of the building to support ceiling-hung toilet partitions. Structure in ceiling, not furnished by Bobrick, must support at least 275 lb per compact grade laminate toilet compartment, and must be sufficiently rigid to withstand swinging motion of toilet partition doors and impact of doors against stiles. Actual mounting system, including lateral bracing, if required, must be designed by the architect or structural engineer, and furnished by others. Wood beams are not recommended for ceiling hung application. **Note:** If adequate ceiling support cannot be provided, the floor-anchored or overhead-braced toilet compartments are recommended.

CONTINUOUS .67 BRACKET (OPTION):

Mounting brackets are constructed of 18-8, Type-304, heavy-gauge stainless steel with satin finish: one-piece, full-height U-channels and angle brackets are 18 gauge (1.2mm). U-channels secure panels to stiles, and angle brackets secure panels and stiles to walls. Theft-resistant, stainless steel pin-in-head, torx screws are furnished for U-channels, Z-bracket and angle brackets. Mounting screws for stile to panel bracket is through-bolted.

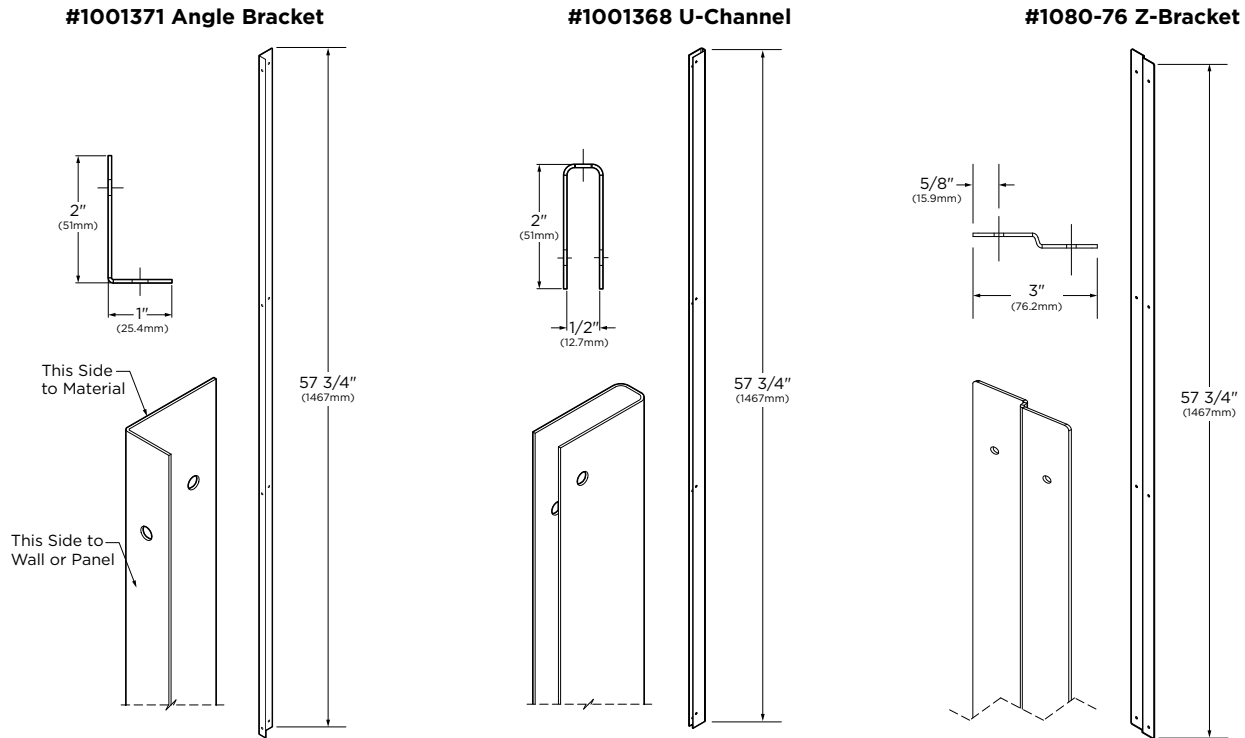

CONTINUOUS .67 HINGES (OPTION):

Hinges are constructed of 18-8, Type-304, heavy-gauge stainless steel with satin finish: one-piece, full-height hinge is 16 gauge (1.6mm); Theft-resistant, stainless steel pin-in-head, torx screws are furnished for door hardware. Doors are equipped with a gravity type self-closing hinge. Threaded inserts are factory installed to secure door hinge. **The continuous hinge (.67 option) depends on the weight of the door to return the hinge to its closed position, which may result in door slamming.**

#1002920
Left-Hand Inswing or
Right-Hand Outswing

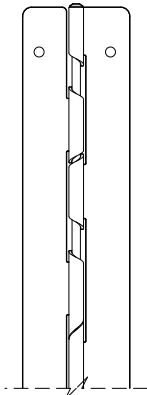
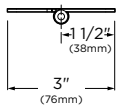

#1002921
Right-Hand Inswing
or Left-Hand Outswing

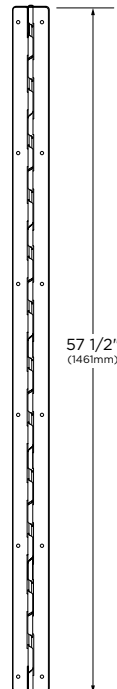
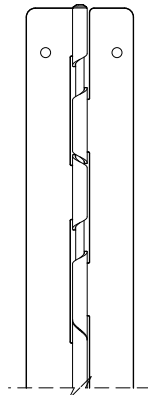
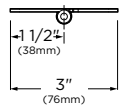

HINGE CAM MAINTENANCE:

Cleaning and lubricating hinge is required to avoid failure of hinge mechanism. Must use a Teflon type based lubricant such as Tri-Flow Superior Lubricant with P.T.F.E. It is not recommended to use machine oil or WD-40 which will collect dust and dirt.

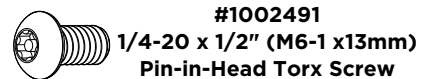

□ OCCUPANCY INDICATOR LATCH (OPTION):

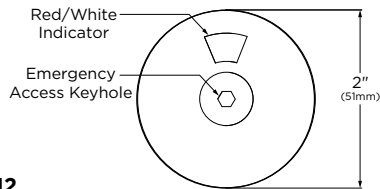

**#1002612
OccupancyIndicator
Latch Packet**

Emergency Access - The latch allows the door to be opened from the exterior of the toilet compartment by inserting a 3mm Allen key into the keyhole in the center of the cover plate and turning the key to release the latch.

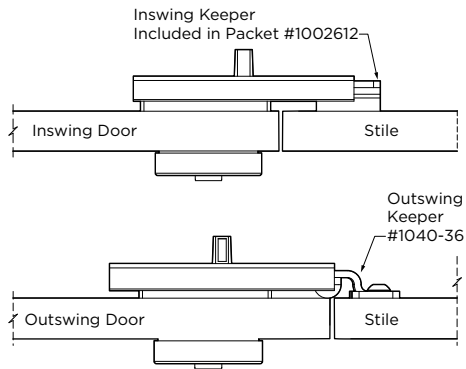

DOOR STOP (OPTION):

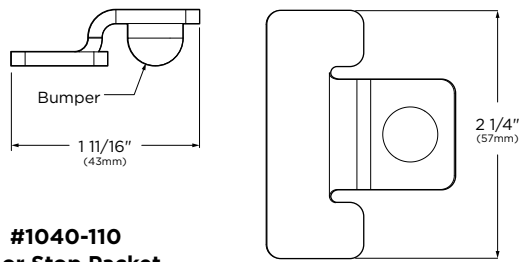

**#1040-110
Door Stop Packet**

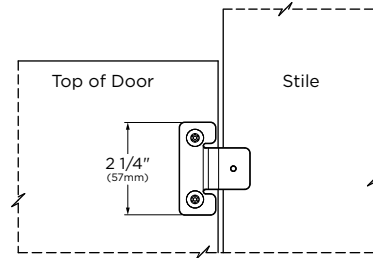
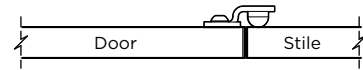

GAP FREE DOORS & STILES (OPTION):

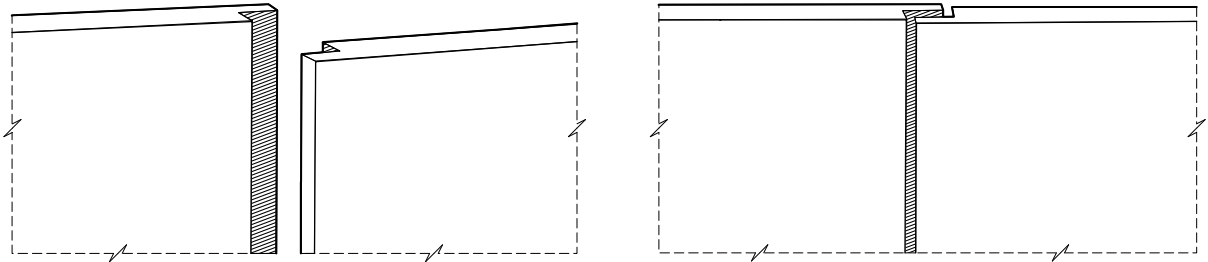

Features: Interlocking, sightline-free design (Gapless).

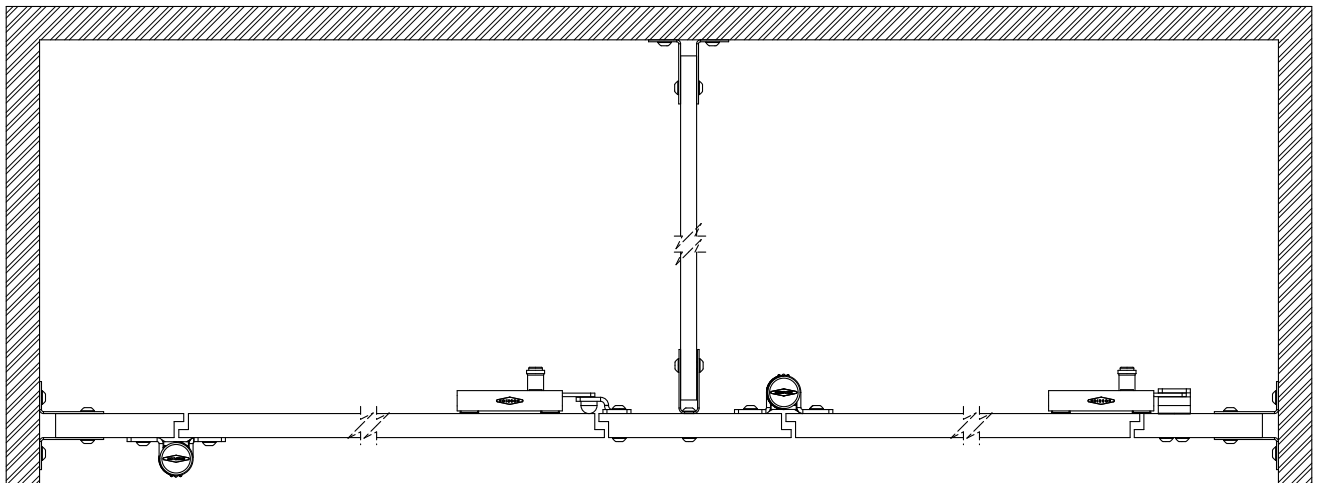

1090 URINAL SCREENS:

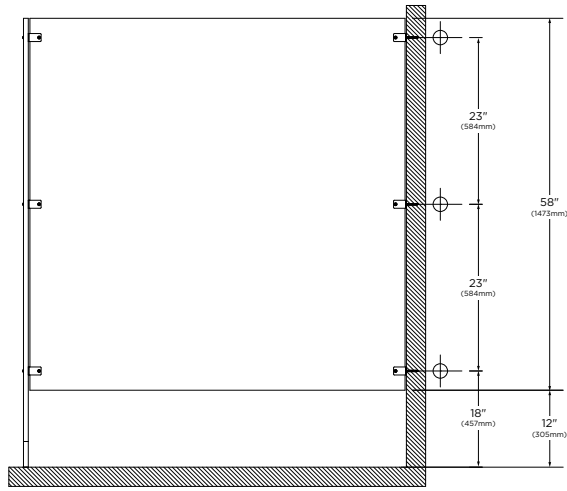

FLOOR ANCHORED URINAL SCREEN

STANDARD:

- #1091 - Standard Bracket

MODEL OPTIONS:

- #1091.67 - Continuous Bracket

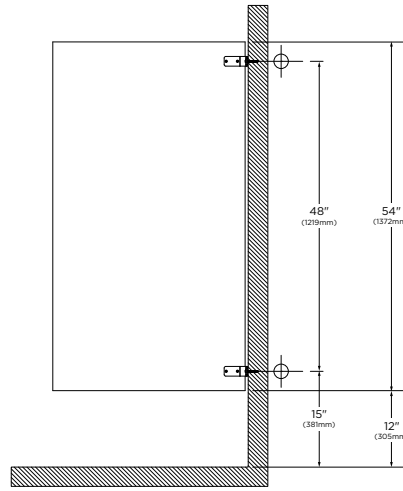

WALL MOUNTED URINAL SCREEN

Up to 54" (1372mm) high.

STANDARD:

- #1095 - Standard Bracket

MODEL OPTIONS:

- #1095.67 - Continuous Bracket

**#1002956
W/H Urinal Screen Bracket**

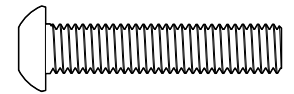
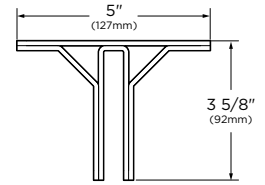
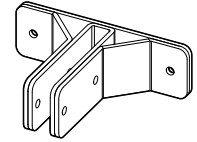

**#1002966
#10-32 x 1-1/4" (38mm)
Pin-in-Head
Torx Screw**



**#1000133
Acorn Nut #10-32
Through-Bolt
Urinal Screen**

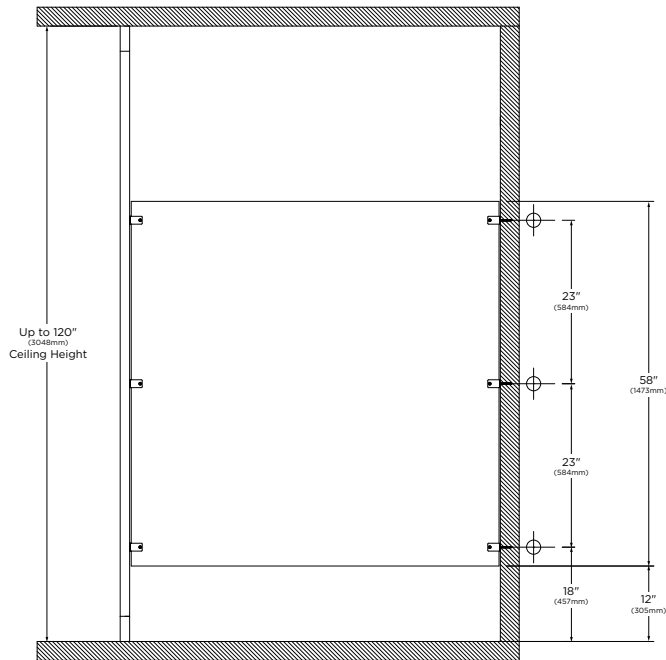

POST-TO-CEILING URINAL SCREEN

STANDARD:

- #1093 - Standard Bracket

MODEL OPTIONS:

- #1093.67 - Continuous Bracket

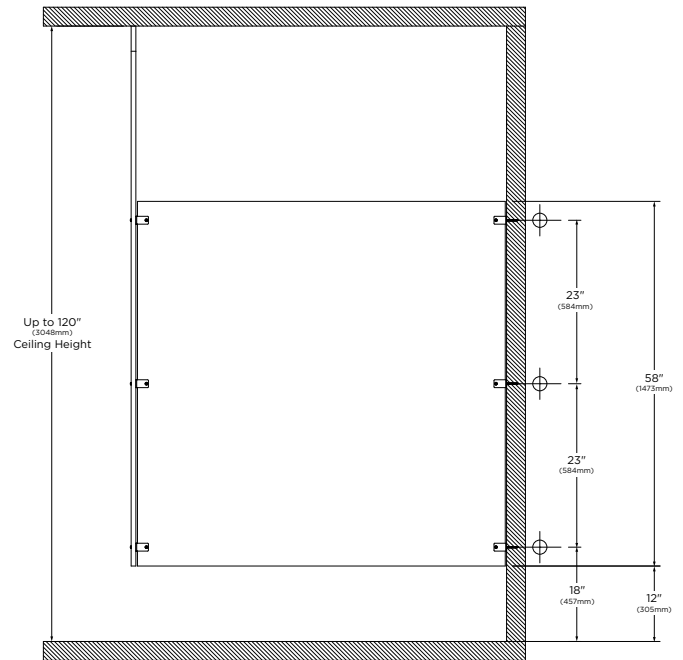

CEILING-HUNG URINAL SCREEN

STANDARD:

- #1098 - Standard Bracket

MODEL OPTIONS:

- #1098.67 - Continuous Bracket

INSTALLATION:

Refer to Bobrick installation instructions packed with each shipment. Also available on bobrick.com. Form No. 1090-69.

NOTES:

1. Ceiling-hung and floor-to-ceiling toilet compartments require structural members (not furnished by Bobrick) in ceiling. For suggested types of ceiling support systems, see Bobrick Advisory Bulletin TB-32.
2. Wall backing is required to secure the mounting brackets of panels, stiles, and wall posts. For suggested wall backing, see Bobrick Advisory Bulletin TB-46.
3. Floor-anchored stiles are furnished with expansion shields and threaded rods. The expansion shields require minimum 2" (50mm) penetration into minimum 3" (75mm) thick structural concrete.
4. Bobrick stainless steel partition-mounted washroom accessories are available for mounting in panels between two compartments. See current Bobrick Catalog for description of accessories. Cutouts in panels can be pre-cut for Bobrick models at factory if location and size of all cutouts and Bobrick model numbers are furnished at time of order.
5. When the hinge cam has been set at the desired free resting position, "either closed or open" the top of the affixed components will be aligned.

GUARANTEE:

Bobrick toilet partitions including all hardware and mounting brackets are guaranteed to be free from defects in material and workmanship for a period of one year from date of purchase. Any products returned to Bobrick under this guarantee will be repaired or replaced at no charge. **25-Year Warranty:** Bobrick extends a twenty-five-year limited warranty from date of purchase for SierraSeries Solid Color Reinforced Composite (SCRC) partition panels, doors, and stiles against breakage, delamination and corrosion when materials are properly installed, and normally used.

SPECIFICATION:

Water- and Fire-Resistant, Solid Color Reinforced Composite (SCRC) _____ (insert one product application: toilet partition, dressing compartment, shower divider, urinal screen) shall be _____ (insert one series: floor-anchored, overhead-braced, post-to-ceiling, wall-hung, floor-to-ceiling anchored, ceiling-hung) _____ (insert one series for Gap-Free: floor-anchored, overhead-braced, floor-to-ceiling anchored, ceiling-hung). Stiles, panels and doors shall be constructed of SCRC with GraffitiOff surface thermoset and integrally fused into one homogeneous piece. Surface, edges and core are to be same color. SCRC material shall be covered by a 25-year limited warranty against breakage, corrosion, and delamination. Stiles and doors shall be 3/4" (19mm) thick; panels shall be 1/2" (13mm) thick. All units shall meet ICC and NFPA Class B or UBC Class II, ASTM E 84 Fire-Resistance Standards. Stiles shall have leveling device that is concealed by a one-piece, Type-304, satin-finish stainless steel shoe that is 4" (102mm) high. Stiles, panels and doors shall be _____ (insert color name and number from current Bobrick Toilet Partition catalog). Headrails for overhead-braced compartments shall be anodized aluminum with satin finish.

All door hardware and mounting brackets shall be Type-304 stainless steel with satin finish. All doors shall be supplied with two hinges. Threaded inserts shall be factory installed for securing door hinges and latches. Theft-resistant, stainless steel pin-in-head Torx screws shall be furnished for door hardware and all mounting brackets. Through bolts shall be used for securing latch keeper, clothes hook and panel-to-stile brackets. Doors shall be equipped with a self-closing hinge. Hinges shall be adjustable to hold doors of unoccupied compartments partially open or fully closed. Hinges shall allow locked compartment to be opened in emergency from outside by lifting door to disengage latch from keeper. A clothes hook shall be furnished for each door.

*To specify Gapless door and stile option, add suffix "G" to series number. Example: specify 1092G.

**To specify Continuous hardware, replace end of specification paragraph with: .67 option All door hardware, U-channels, and angle brackets shall be Type-304 stainless steel with satin finish: one-piece, full-height hinges shall be 16 gauge (1.6mm); one-piece door keeper shall be 11 gauge (3.2mm); one-piece, full-height U-channels and angle brackets shall be 18 gauge (1.2mm). U-channels shall be furnished to secure panels to stiles, and angle brackets furnished to secure panels and stiles to walls. Theft-resistant, stainless steel pin-in-head, Torx screws shall be furnished for door hardware, U-channels, and angle brackets. Through bolts shall be used for securing latch keeper and panel-to-stile brackets. Threaded inserts shall be factory installed to secure all door hinges and latches.

_____ (insert one: Toilet Partitions, Dressing Compartments, Shower Dividers, Urinal Screens, Entrance Screens) shall be _____ Series (insert series number) of Bobrick Washroom Equipment, Inc., Clifton Park, New York; Jackson, Tennessee; Los Angeles, California; Bobrick Washroom Equipment Company, Scarborough, Ontario; Bobrick Washroom Equipment Pty. Ltd., Australia; and Bobrick Washroom Equipment Limited, United Kingdom.