

# 830 SureFlo® Soap Systems Installation Instructions

Foam Soap Cabinet ..... Pages 2-9  
Liquid Soap Cabinet ..... Pages 10-18  
Low Soap Indicator ..... Page 19



**SUREFLO®**  
SOAP DISPENSING SYSTEM



BUILDING VALUE SINCE 1906

# INSTALLATION INSTRUCTIONS

## SureFlo® SOAP DISPENSING SYSTEM

### FOAM VERSION ONLY



**B-830 Foam Soap Cabinet Installation ..... Pages 2-8**  
Prior to beginning installation, read instructions and familiarize yourself with parts and procedure.









**BUILDING VALUE SINCE 1906**

# Parts List

Items Included			Purchase Separately		
Part #	Description	Qty.	Part #	Description	Qty.
830-306	Bladder Assembly	1	<b>833-359 Soap Pump Assembly</b>		
			<b>4" Spout</b>	<i>(Items Included in Assembly)</i>	1
830-57	Drip Tray	1	833-22	Foam Dispensing Assy	1
830-278	Brackets	2	833-34	Basin Mounting Kit	1
830-215	Low Soap Indicator (LSI) Retrofit Kit	1	833-341	Soap Pump Connector Kit	1
830-415	Low Soap Indicator Battery Pack Replacement Kit	1	<b>833-372 Soap Pump Assembly with Shank</b>		
			<b>6" Spout</b>	<i>(Items Included in Assembly)</i>	1
830-207	Hardware Packet	1	833-22	Foam Dispensing Assy	1
	<i>(Items Included in Packet)</i>		833-34	Basin Mounting Kit	1
687-6	Spacer	1	833-341	Soap Pump Connector Kit	1
830-242	Adhesive Tape	1	<i>833-341 Included in 833-359 and 833-372 Soap Pump Assemblies</i>		
1000160	Toggle Bolt	6	<b>833-162 Tubing 25' Packet</b>		1
1000085	Stud Screw	6	<b>833-341 Soap Pump Connector Kit</b>		
5067-11	Washer	6	<i>(Items Included in Kit)</i>		1
232-11	Hex Nut	2	833-110	Vertical Tube 10" Length	1
576-181	Lock Washer	2	833-311	Tee, 3-Barb	1
24-17	BobKey	1	830-312	Reducing Connector, 3-Barb	1
<b>833-164 Tubing Connector Packet</b>		1	833-72	Intermediate Tube 50" Length	1
	<i>(Items Included in Packet)</i>		830-28	Cable Support	2
833-113	Inline Tubing Connector	1	124-62	Cable Tie	2
833-16	Snapper Clamp		528-19	Screw Packet (4 Screws)	1 packet

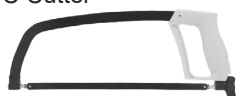
## Tools Required

<p><b>Drill</b></p>  <p>Drill Bits 5/8" diameter for Toggle bolt 3/16" diameter for Stud Screw Masonry Bit for Tile</p>	<p><b>Pliers</b></p>  <p><b>Tape Measure and Pencil</b></p> 	<p><b>Level</b></p>  <p><b>Screw Drivers</b> Phillips Slotted #2 and #3</p> 	<p><b>PVC Cutter</b></p>  <p><b>Utility Knife or Cutter</b></p> 
---	--	--	--

# Cabinet Installation

1. Tape Template to desired position and mark holes as indicated:

Cabinet can be installed on left or right side of wall. Clearance: If cabinet is mounted under soap pump, allow 5" (130mm) under top surface of counter for shank extension connection.

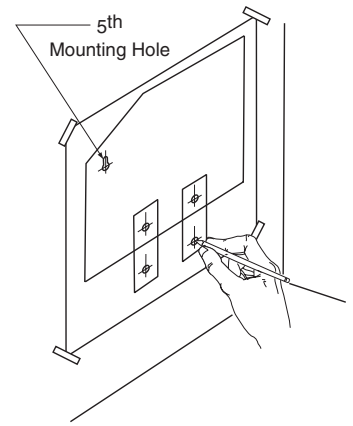

2. Drill 5/8" holes as marked by template.

If drilling into stud, drill 3/16" hole. Provide adequate backing where necessary.

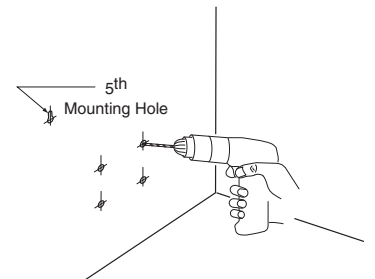

3. **Important:** Keep bolt loose until cabinet has been placed on brackets.

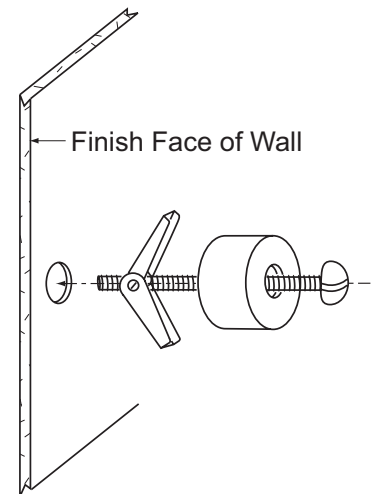

4. Attach Brackets to Wall with Toggle Bolts (supplied). Use a level to ensure brackets are leveled horizontally.

*\* For Tile Only: Bottom 2 toggle bolts can be replaced with #10 screws and blue anchors (not provided).*

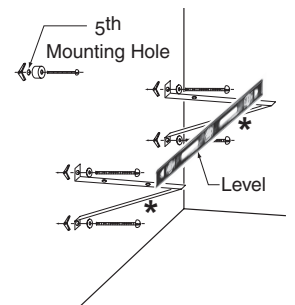

5. Route tubing through hole in cabinet side panel or back wall.

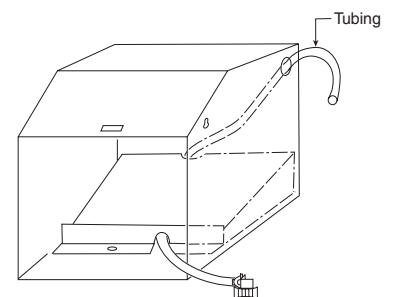

## Cabinet Installation cont'd

6. Place double sided adhesive tape on top of back bracket and remove protective strip from adhesive.

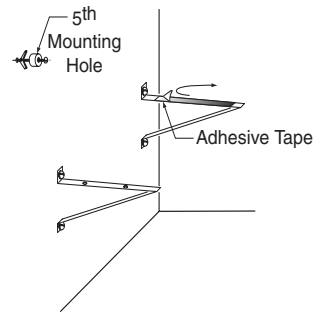

7. Without lowering the back of the cabinet. Place Cabinet on front Bracket aligning weld studs on bottom of cabinet through holes in front bracket and gently place back of cabinet on the back bracket which has the adhesive tape.

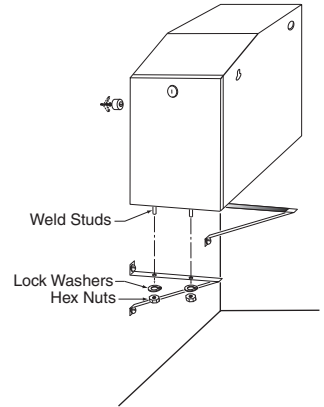

8. Place 2 lock washers and 2 hex nuts supplied on the weld studs on bottom of cabinet and tighten to secure cabinet to front bracket.

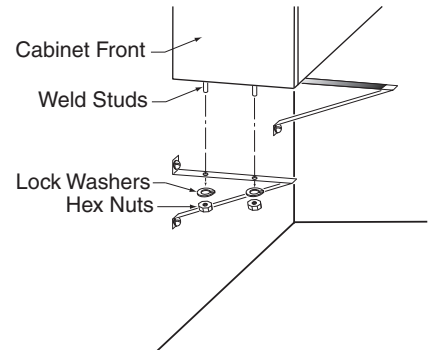

9. To secure cabinet to wall, insert 5th Toggle Bolt head through key hole located at top side of cabinet. Slide bolt head through top of keyhole and tighten.

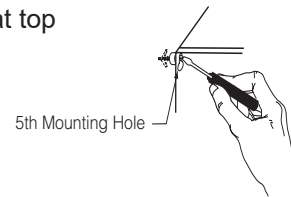

10. Hook up Low Soap Indicator (LSI) Light.

Connect two "C" sized batteries (batteries not included) to battery connector. Place clear lens through the hole from outside of cabinet. Insert Black retaining ring on clear lens. Insert LED (Red Light) from the inside, through the retainer ring into clear lens.

**Note:** Red LED Light should flash when the batteries are connected. LED light will stop flashing when reservoir bladder is filled with soap. (Red light may flash for 3-6 hours after SureFlo soap cartridge is connected.)

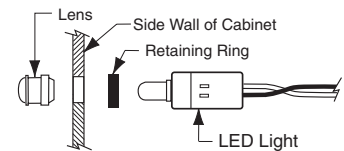

## **Tubing Connections and Soap Pump Installation** (Existing and New Soap Dispensers)

1. For new installations, mount Shank. Make sure countertop surface around mounting hole is clean and free of soap residue. Insert Shank through 1" (25mm) diameter hole. *Make sure the Black Rubber Gasket is in place between the countertop and Shank.* Place 822-43 Rosette Washer and Mounting Nut onto Shank under countertop. *Tighten Mounting Nut against underside of countertop.*

*Caution: Do not over-tighten Mounting Nut.*

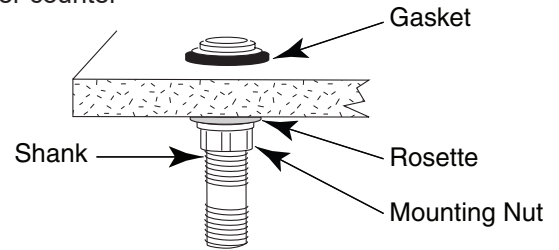

2. Insert soap pump assemblies with vertical tubes into Shanks.

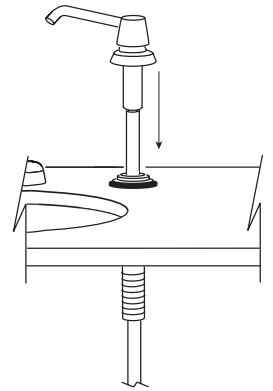

3. Secure the escutcheons by turning clockwise until lock snaps into position. Position Spout over the lavatory.

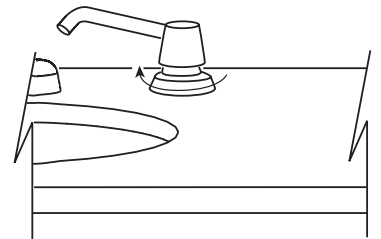

4. Connect Tubing from cabinet to 830-312 Reducer - Connect Reducer to 3-Barb Tee placed under first soap pump in the line using supply tube provided. Make sure tube is completely engaged on the Tee fitting.

**Note:** Excess tubing may need to be cut-off.

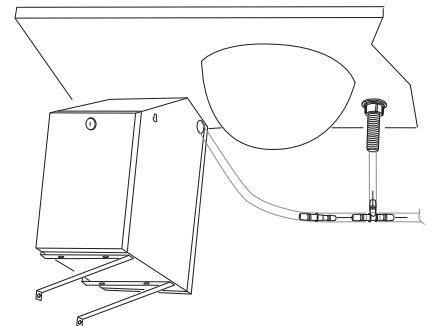

# **Tubing Connections and Soap Pump Installation** (Existing and New Soap Dispensers)

5. Connect bottom end of all soap pump vertical tubes to vertical arms of all Tees except the last soap pump in the line.

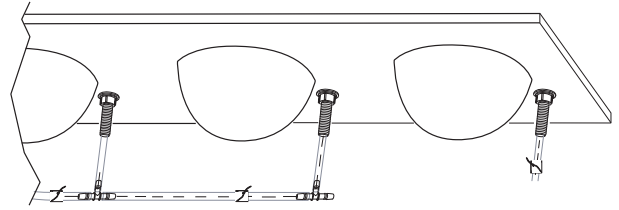

6. Connect a length of 833-72 Intermediate Tubing from the first Tee to the next Tee locations. Cut Tubing to desired length between soap pumps and connect to successive locations except the last soap pump in the line. Make sure tube is completely engaged on the Tee fittings.

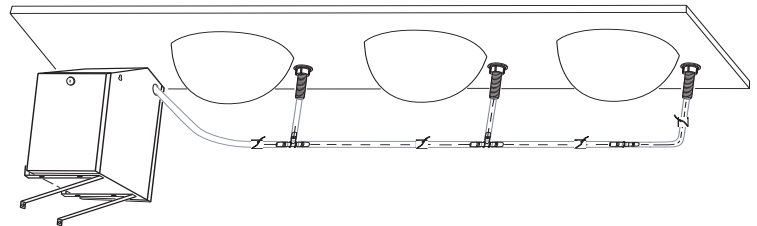

7. Connect intermediate tube to last horizontal arm of Tee at next to last soap pump in the line. Connect to other end of last intermediate tube under last soap pump in the line. Connect bottom end of vertical tube of the last 833-113 Make sure tube is completely engaged on the fittings.

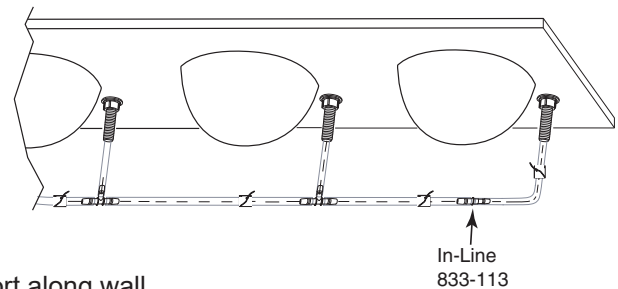

8. Screw Cable Supports into wall between each Soap Pump to support along wall.

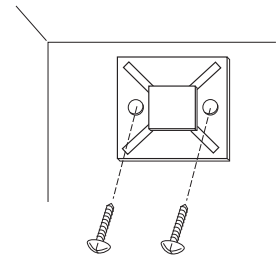

9. Attach intermediate tubing to cable supports with the cable ties between soap pumps.

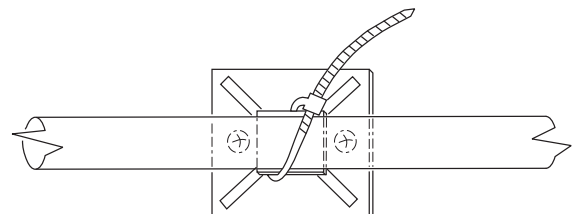

# Prime Soap System

1. Place Soap Tank Cartridge into Soap Cabinet and remove protective cover.

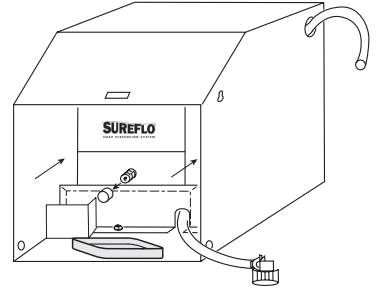

2. Screw Soap Supply Line Cap to Cartridge Outlet by turning clockwise. Soap should flow through the tubing.

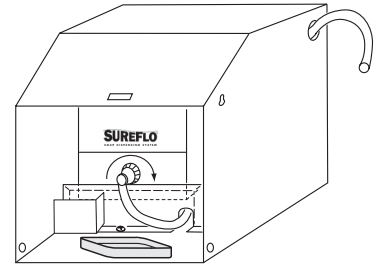

3. Prime Soap System beginning with the dispenser closest to Cabinet until soap is dispensed.

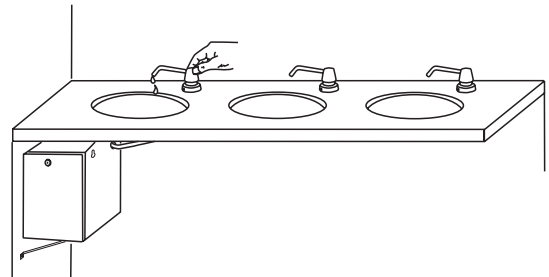

4. Pump each successive dispenser until soap is dispensed and the entire line of tubing is free of air and filled with soap.

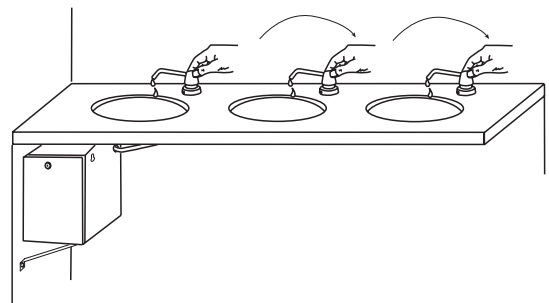





**BUILDING VALUE SINCE 1906**

**In the United States: BOBRICK WASHROOM EQUIPMENT, INC.**

Los Angeles: 6901 Tujunga Avenue., North Hollywood, CA 91605-6213, Tel: 818.982.9600, Fax: 818.503.9287

New York: 200 Commerce Drive, Clifton Park, NY 12065-1350, Tel: 518.877.7444, Fax: 518.877.5029

or email [customerservice@bobrick.com](mailto:customerservice@bobrick.com)

**In Canada: BOBRICK WASHROOM EQUIPMENT COMPANY**

45 Rolark Drive, Toronto, Ontario M1R 3B1, Eastern Canada: Tel: 877.423.6555, Fax: 423.765.8555;

Western Canada: Tel: 877.423.6444, Fax: 423.503.8444

SureFlo® is a trademark of Bobrick Washroom Equipment, Inc.

# INSTALLATION INSTRUCTIONS

## SureFlo® SOAP DISPENSING SYSTEM

### LIQUID VERSION ONLY











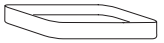

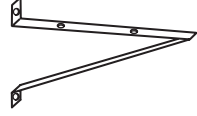
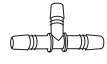













**B-830 Liquid Soap Cabinet Installation..... Pages 10-18**  
Prior to beginning installation, read instructions and familiarize yourself with parts and procedure.

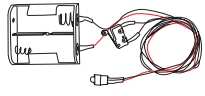

**BUILDING VALUE SINCE 1906**

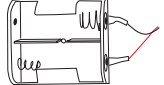
# Parts List

Items Included				Purchase Separately			
Part #	Description		Qty.	Part #	Description		Qty.
830-306	Bladder Assembly		1	830-341	Soap Pump Conversion Kit <i>(Items Included in Kit)</i>		1
830-57	Drip Tray		1	830-313	Vertical Tube 10" Length		1
830-278	Brackets		2	830-311	Tee, 3-Barb		1
830-207	Hardware Packet <i>(Items Included in Packet)</i>		1	830-312	Reducing Connector, 3-Barb		1
687-6	Spacer		1	830-72	Intermediate Tube 50" Length		1
830-242	Adhesive Tape		1	830-28	Cable Support		2
1000160	Toggle Bolt		6	124-62	Cable Tie		2
1000085	Stud Screw		6	528-19	Screw Packet		1
5067-11	Washer		6	830-162	Tubing 25' Length		1
232-11	Hex Nut		2	822-408	Long Shank <i>for Countertops more than 1-3/4" (45mm) Thick</i>		1
576-181	Lock Washer		2	830-359	Soap Pump Assembly with Shank 4" Spout <i>(Items Included in Assembly)</i>		1
24-17	BobKey		1	830-355	Soap Pump		1
830-113	Inline Tubing Connector		1	8221-402	Short Shank		1
830-16	Snapper Clamp		2	830-372	Soap Pump Assembly with Shank 6" Spout <i>(Items Included in Assembly)</i>		1
830-215	Low Soap Indicator (LSI) Retrofit Kit		1	830-356	Soap Pump		1
830-415	Low Soap Indicator Battery Pack Replacement Kit		1	8221-402	Short Shank		1

## Tools Required

Drill



Drill Bits  
5/8" diameter for Toggle bolt  
3/16" diameter for Stud Screw  
Masonry Bit for Tile



Pliers



Tape Measure and Pencil



Level



Screw Drivers  
Phillips  
Slotted #2 and #3



PVC Cutter or Hack Saw



Utility Knife or Cutter



# Cabinet Installation

1. Tape Template to desired position and mark holes as indicated:

Cabinet can be installed on left or right side of wall. Clearance: If cabinet is mounted under soap pump, allow 5" (130mm) under top surface of counter for shank extension connection.

**Thick Countertop  
Installer Note:**

If counter top is more than 1-3/4" (45mm) thick and a 6" (150mm) shank (Part No. 822-408) is used, 8" (205mm) clearance under top surface of counter is required.

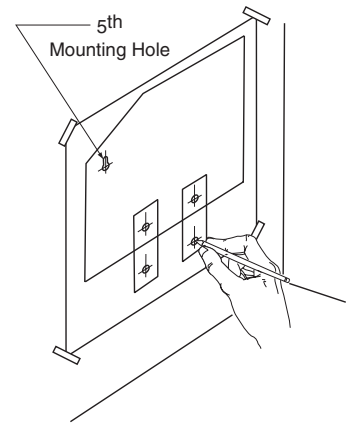

2. Drill 5/8" holes as marked by template.

If drilling into stud, drill 3/16" hole. Provide adequate backing where necessary.

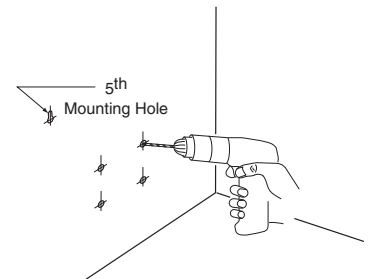

3. **Important:** Keep bolt loose until cabinet has been placed on brackets.

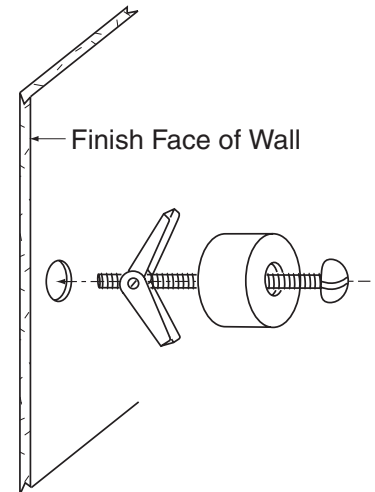

4. Attach Brackets to Wall with Toggle Bolts (supplied). Use a level to ensure brackets are leveled horizontally.

*\* For Tile Only: Bottom 2 toggle bolts can be replaced with #10 screws and blue anchors (not provided).*

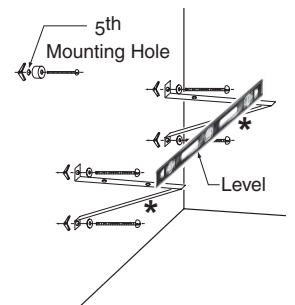

5. Route tubing through hole in cabinet side panel or back wall.

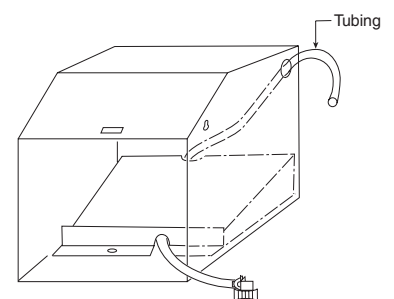

## Cabinet Installation cont'd

6. Place double sided adhesive tape on top of back bracket and remove protective strip from adhesive.

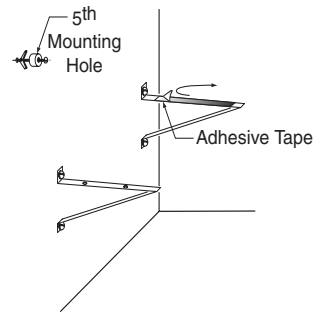

7. Without lowering the back of the cabinet. Place Cabinet on front Bracket aligning weld studs on bottom of cabinet through holes in front bracket and gently place back of cabinet on the back bracket which has the adhesive tape.

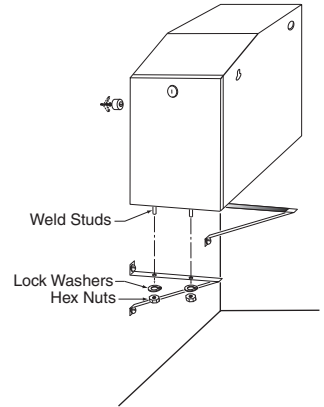

8. Place 2 lock washers and 2 hex nuts supplied on the weld studs on bottom of cabinet and tighten to secure cabinet to front bracket.

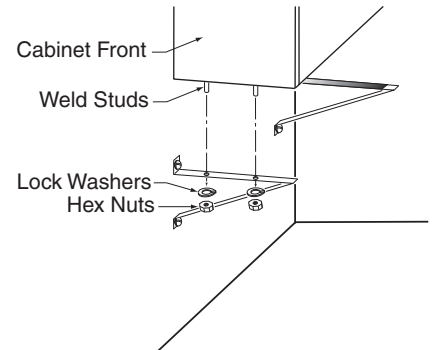

9. To secure cabinet to wall, insert 5th Toggle Bolt head through key hole located at top side of cabinet. Slide bolt head through top of keyhole and tighten.

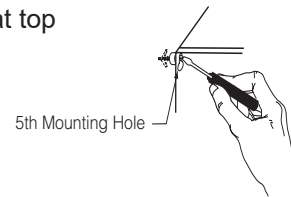

10. Hook up. Low Soap Indicator (LSI) Light.

Connect two "C" sized batteries (batteries not included) to battery connector. Place clear lens through the hole from outside of cabinet. Insert Black retaining ring on clear lens. Insert LED (Red Light) from the inside, through the retainer ring into clear lens.

**Note:** Red LED Light should flash when the batteries are connected. LED light will stop flashing when reservoir bladder is filled with soap. (Red light may flash for 3-6 hours after SureFlo soap cartridge is connected.)

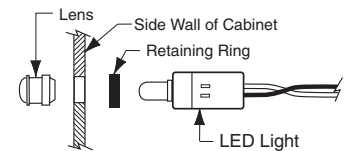

## Tubing Connections and Soap Pump Installation (Existing and New Soap Dispensers)

1. Remove Existing B-822 Dispenser pump(s), Soap Bottle(s) and Cap(s), if applicable.

*Caution - Black rubber must be between plastic shank and countertop.*

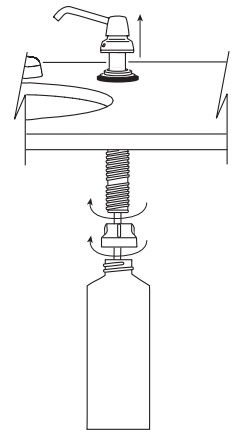

2. If existing B-822 Shank is 6" long, you may cut shank at non-threaded area in the center with a PVC cutter or hack saw, if desired.

### Thick Countertop

#### Installer Note:

If counter top is more than 1-3/4" (45mm) thick, use standard 6" (105mm) shank (Part No. 822-408) without cutting it. 8" (205mm) clearance under top surface of counter is required.

For new installations, mount 8221-408 Short Shank 3" (75mm) for installation in most countertops or 822-408 Long Shank 6" (150mm) for countertops thicker than 1-3/4" (45mm). Make sure countertop surface around mounting hole is clean and free of soap residue. Insert Shank through 1" (25mm) diameter hole. *Make sure the Black Rubber Washer is in place between the countertop and Shank.* Place 822-43 Rosette Washer and Retaining Nut onto Shank under counter top. *Tighten Retaining Nut against underside of countertop.*

*Caution: Do not over-tighten Retaining Nut.*

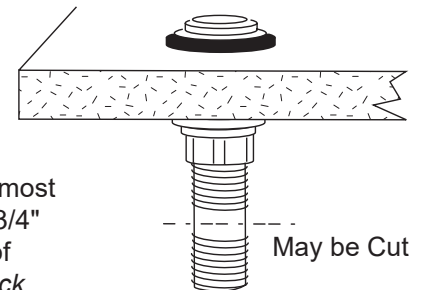

3. Connect 830-313 vertical tubes to 3-barb connections of all Soap Pump Cylinders. Make sure tube is completely engaged on the Cylinder fittings.

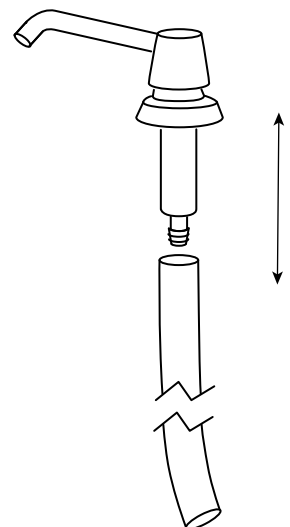

## **Tubing Connections and Soap Pump Installation** (Existing and New Soap Dispensers)

4. Insert soap pump assemblies with vertical tubes into Shanks.

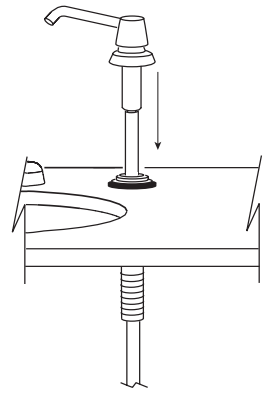

5. Secure the escutcheons by turning clockwise until lock snaps into position. Position Spout over the lavatory.

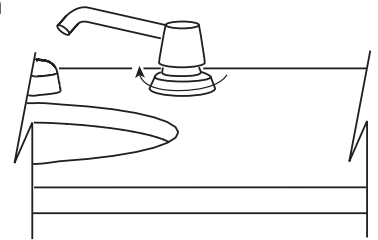

6. Connect Tubing from cabinet to one horizontal arm of 830-311 3-Barb Tee placed under first soap pump in the line. Make sure tube is completely engaged on the Tee fitting.

**Note:** Excess tubing may need to be cut-off.

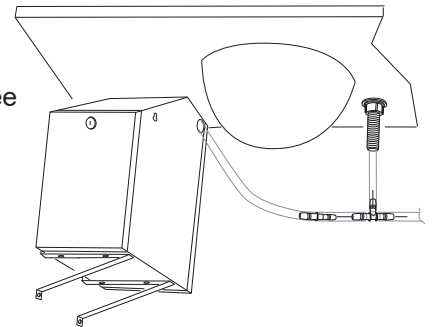

7. Connect bottom end of all soap pump vertical tubes to vertical arms of all Tees except the last soap pump in the line.

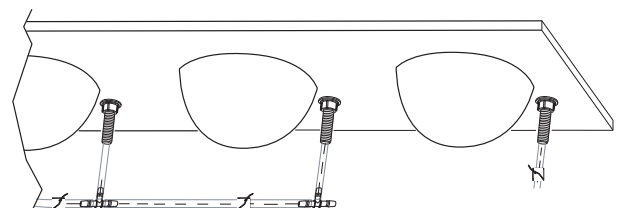

## **Tubing Connections and Soap Pump Installation** (Existing and New Soap Dispensers)

8. Connect a length of 830-72 Intermediate Tubing from the first Tee to the next Tee locations. Cut Tubing to desired length between soap pumps and connect to successive locations except the last soap pump in the line. Make sure tube is completely engaged on the Tee fittings.

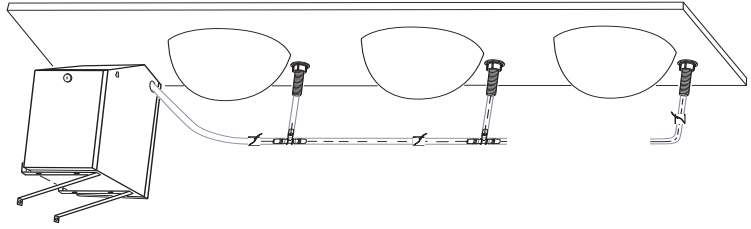

9. Connect intermediate tube to last horizontal arm of Tee at next to last soap pump in the line. Connect 830-312 3-barb reducing connector to other end of last intermediate tube under last soap pump in the line. Connect bottom end of vertical tube of the last soap pump in the line to small end of 830-312 3-Barb reducing connector. Make sure tube is completely engaged on the fittings.

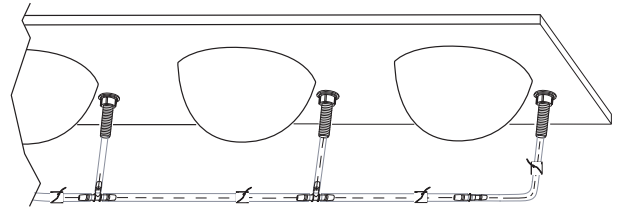

10. Screw Cable Supports into wall between each Soap Pump to support along wall.

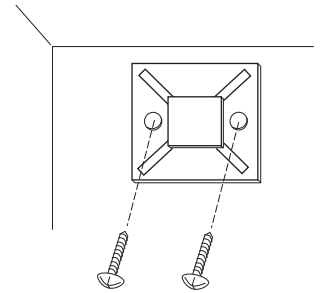

11. Attach intermediate tubing to cable supports with the cable ties between soap pumps

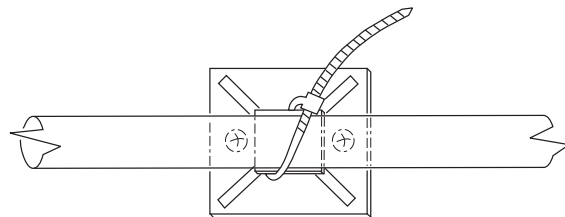



# Prime Soap System

1. Place Soap Tank Cartridge into Soap Cabinet and remove protective cover.

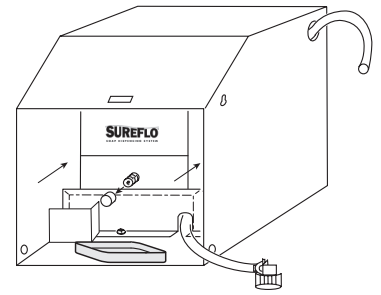

2. Screw Soap Supply Line Cap to Cartridge Outlet by turning clockwise. Soap should flow through the tubing.

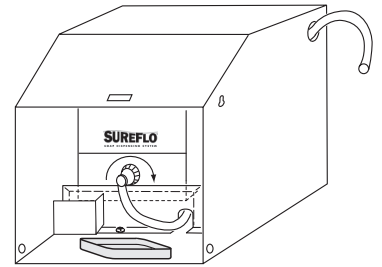

3. Prime Soap System beginning with the dispenser closest to Cabinet until soap is dispensed.

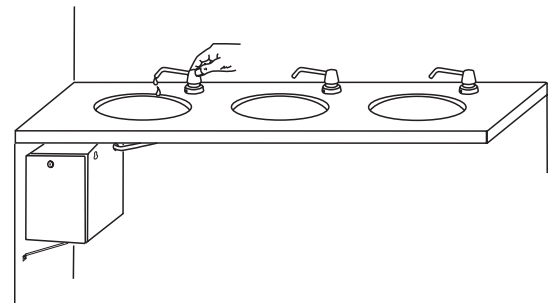

4. Pump each successive dispenser until soap is dispensed and the entire line of tubing is free of air and filled with soap.

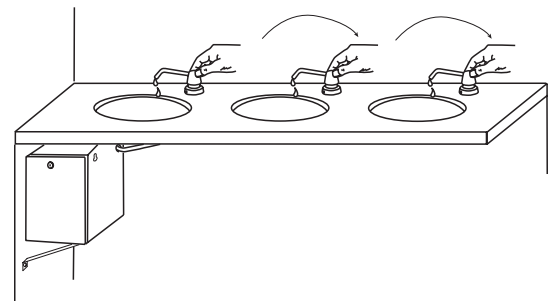



**BUILDING VALUE SINCE 1906**

**In the United States: BOBRICK WASHROOM EQUIPMENT, INC.**

Los Angeles: 6901 Tujunga Avenue., North Hollywood, CA 91605-6213, Tel: (818) 982-9600, Fax: 818-503-1102  
New York: 200 Commerce Drive, Clifton Park, NY 12065-1350, Tel: (518) 877-7444, Fax: 518-877-5029  
or email [customerservice@bobrick.com](mailto:customerservice@bobrick.com)

**In Canada: BOBRICK WASHROOM EQUIPMENT COMPANY**

45 Rolark Drive, Toronto, Ontario M1R 3B1, Eastern Canada: Tel: (877) 423-6555, Fax: (877) 423-8555;  
Western Canada: Tel: (877) 423-6444, Fax: (877) 423-8444

SureFlo® is a trademark of Bobrick Washroom Equipment, Inc.



## INSTALLATION INSTRUCTIONS

BOBRICK PART NUMBER 830-215 LOW SOAP INDICATOR (LSI) RETROFIT KIT

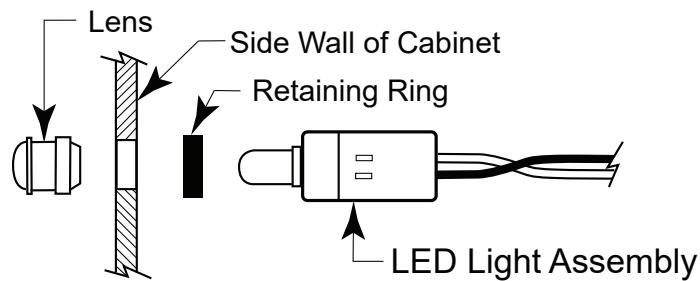

FIGURE 1

### 830-215 LOW SOAP INDICATOR (LSI) RETROFIT KIT:

- Battery Pack requires two "C" Cell Batteries (batteries not included)
- Clear Lens
- Retaining Ring

### Function

When Low Soap Indicator Light flashes, Soap Cartridge must be replaced to allow for uninterrupted flow of soap through SureFlo Soap System.

### Instructions

1. Insert "C" batteries into battery clip and place in holder (located in front of the Bladder Tray assembly).
2. Insert clear lens through visible, side wall of the cabinet (**See Figure 1**).
3. Attach retaining ring to lens.
4. Attach LED light to lens.

**Note:** For a new Cabinet Installation, the LSI light will continue to flash for up to 3 hours until the bladder is full of soap.



BUILDING VALUE SINCE 1906

© 2021 by Bobrick Washroom Equipment, Inc.  
Form No. 830-229 r8/6/21 Printed in U.S.A.

### In the U.S.A.: BOBRICK WASHROOM EQUIPMENT, INC.

200 Commerce Drive, Clifton Park, New York 12065-1350 • Tel: 518.877.7444 • FAX: 518.877.5029  
6901 Tujunga Avenue, North Hollywood, California 91605-6213 • Tel: 818.982.9600 • FAX: 818.503.9287

### In Canada: BOBRICK WASHROOM EQUIPMENT COMPANY

45 Rolark Drive, Toronto, Ontario M1R 3B1, Eastern Canada: Tel: 877.423.6555, Fax: 423.765.8555;  
Western Canada: Tel: 877.423.6444, Fax: 423.503.8444